

Dimension: 1.75" w x 0.40" h

# T01 LAMINATE T-MOLDING

Used to fill the gap between two floors of equal height. Most common areas are in doorways or to join two laminate floors.

Used with floors 7-10mm in height.

**Surface:** Wear resistant laminate  
**Core Material:** Moisture resistant MDF

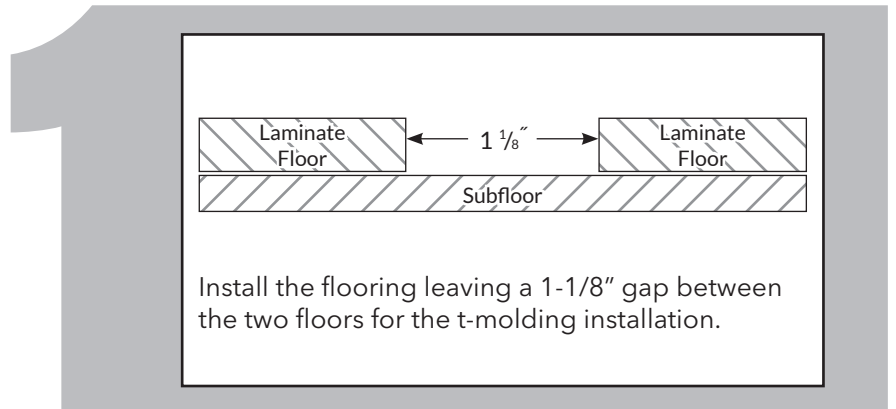

Install the flooring leaving a 1-1/8" gap between the two floors for the t-molding installation.

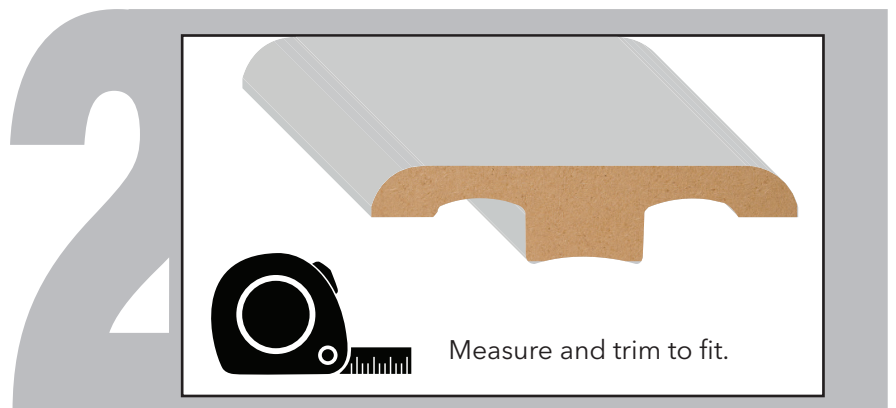

Measure and trim to fit.

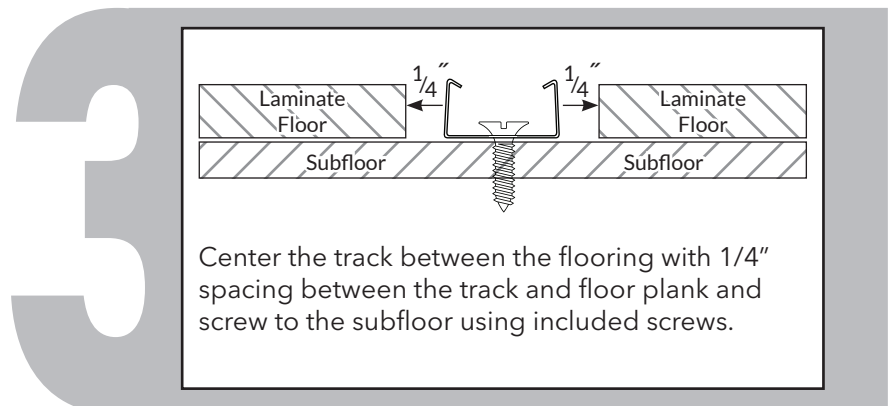

Center the track between the flooring with 1/4" spacing between the track and floor plank and screw to the subfloor using included screws.

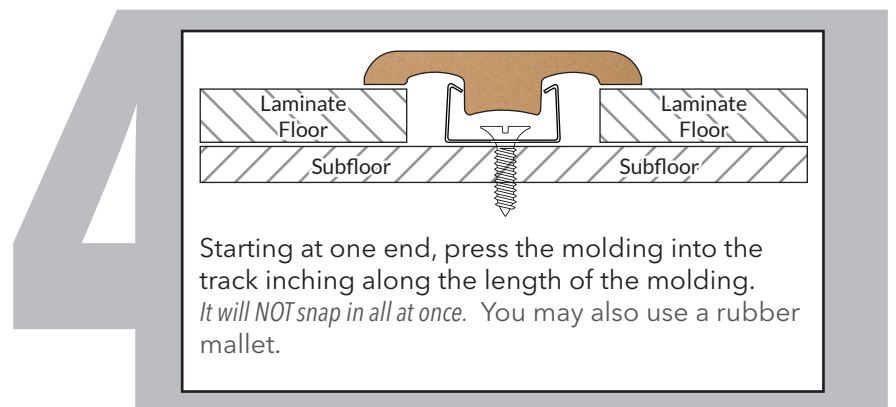

Starting at one end, press the molding into the track inching along the length of the molding. *It will NOT snap in all at once.* You may also use a rubber mallet.